



MSW2T-2030-192/MSW2T-2031-192/MSW2T-2032-192

SP2T Surface Mount High Power PIN Diode Switch

Features:

- Wide Operating Frequency Band: 50 MHz to 6 GHz
- Surface Mount SP2T Switch: 5mm x 8mm x 2.5mm
- Industry Leading Average Power Handling: 100W CW
- High RF Peak Power: 550W
- Low Insertion Loss: < 0.25 dB
- High IP3 >65 dBm
- High Linearity
- RoHS Compliant

Description:

The MSW2T-203X-192series SP2T surface mount High Power PIN Diode switches are available in three operating frequency bands: MSW2T-2030-192 operates from 50 MHz to 1 GHz; MSW2T-2031 operates from 400 MHz to 4 GHz , and MSW2T-2032-192 operates from 2 GHz to 6 GHz. The MSW2T-203X-192 Series of high power switches leverage high reliability hybrid manufacturing processes which yield proven superior performance relative to both MMIC and Glass Carrier based technologies. The hybrid design approach permits precise PIN Diode selection to optimize RF performance while maintaining competitive cost targets. The small form factor (8mm x 5mm x 2.5mm) offers world class power handling, low insertion loss, and superior intermodulation performance exceeding all competitive technologies.

Typical Applications:

- Radar T/R Modules
- Switch Bank Filters
- Mil-Com Radios

The MSW2T-203X-192 series of High Power SP2T switches are intended for use in high power, high reliability, mission critical applications across the HF to C Band frequency ranges. The manufacturing process has been proven through years of extensive use in high reliability applications.

ESD and Moisture Sensitivity Level Rating:

The MSW2T-203X-192 family of SP2T switches are fully RoHS compliant. They possess an ESD rating of Class 1C, Human Body Model (HBM) and a moisture sensitivity rating of MSL 1.

MSW2T-203X-192 Schematic

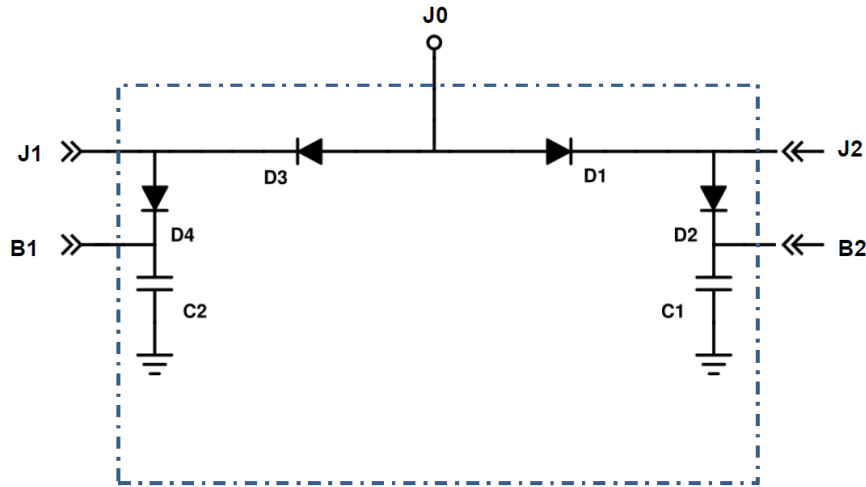

MSW2T-2030-192Electrical Specifications @ Zo = 50Ω; Ta = +25°C

Parameter	Symbol	Test Conditions	Min Value	Typical Value	Max Value	Units
Frequency	F		50		1,000	MHz
J0-J1 or J0-J2 Insertion Loss (Note 1)	IL	Bias State 1: port J0 to J1 Bias State 2: port J0 to J2		0.30	0.40	dB
J0-J1 or J0-J2 Return Loss (Note 1)	RL	Bias State 1: port J0 to J1 Bias State 2: port J0 to J2	20	22		dB
J0-J1 or J0-J2 Isolation (Note 1)	ISO	Bias State 1: port J0 to J1 Bias State 2: port J0 to J2	50	52		dB
CW Incident Power (Note 1)	P _{inc} (CW)	1.5:1 Source & Load VSWR		50	51	dBm
Peak Incident Power (Note 1)	P _{inc} (Pk)	1.5:1 Source & Load VSWR; pw = 10 us, duty cycle = 1%		57		dBm
Switching Speed	t _{sw}	(10%-90%) RF Voltage TTL rep rate = 100 kHz		750	1,000	ns
Input 3 rd Order Intercept Point	IIP3	F1 = 500 MHz F2 = 510 MHz P1 = P2 = +10 dBm Measured on path biased to low loss state	60	65		dBm

MSW2T-2031-192 Electrical Specifications @ $Z_0 = 50\Omega$; $T_a = +25^\circ\text{C}$

Parameter	Symbol	Test Conditions	Min Value	Typical Value	Max Value	Units
Frequency	F		400		4,000	MHz
J0-J1 or J0-J2 Insertion Loss (Note 1)	IL	Bias State 1: port J0 to J1 Bias State 2: port J0 to J2		0.4	0.6	dB
J0-J1 or J0-J2 Return Loss (Note 1)	RL	Bias State 1: port J0 to J1 Bias State 2: port J0 to J2	14	16		dB
J0-J1 or J0-J2 Isolation (Note 1)	ISO	Bias State 1: port J0 to J1 Bias State 2: port J0 to J2	32	35		dB
CW Incident Power (Note 1)	P inc (CW)	1.5:1 Source & Load VSWR		50	51	dBm
Peak Incident Power (Note 1)	P inc (Pk)	1.5:1 Source & Load VSWR; pw = 10 us, duty cycle = 1%		57		dBm
Switching Speed	Ts	(10%-90%) RF Voltage TTL rep rate = 100 kHz		750	1,000	ns
Input 3 rd Order Intercept Point	IIP3	F1 = 2,000 MHz F2 = 2,010 MHz P1 = P2 = +10 dBm Measured on path biased to low loss state	60	65		dBm

MSW2T-2032-192 Electrical Specifications @ $Z_0 = 50\Omega$; $T_a = +25^\circ\text{C}$

Parameter	Symbol	Test Conditions	Min Value	Typical Value	Max Value	Units
Frequency	F		2		6	GHz
J0-J1 or J0-J2 Insertion Loss (Note 1)	IL	Bias State 1: port J0 to J1 Bias State 2: port J0 to J2		0.6	0.8	dB
J0-J1 or J0-J2 Return Loss (Note 1)	RL	Bias State 1: port J0 to J1 Bias State 2: port J0 to J2	11	13		dB
J0-J1 or J0-J2 Isolation (Note 1)	ISO	Bias State 1: port J0 to J1 Bias State 2: port J0 to J2	32	35		dB
CW Incident Power (Note 1)	Pinc (CW)	1.5:1 Source & Load VSWR		50	51	dBm
Peak Incident Power (Note 1)	P inc (Pk)	1.5:1 Source & Load VSWR; pw = 10 us, duty cycle = 1%		57		dBm
Switching Speed	Ts	(10%-90%) RF Voltage TTL rep rate = 100 kHz		750	1,000	ns
Input 3 rd Order Intercept Point	IIP3	F1 = 2,000 MHz F2 = 2,010 MHz P1 = P2 = +40 dBm -180V @ -50 mA (ON) +1V @ +25 mA (OFF)	60	65		dBm

Control Conditions Table

	State 1	State 2
Test Conditions	J0-J1 in Low Insertion Loss J0-J2 in Isolation	J0-J1 in Isolation J0-J2 in Low Insertion Loss
B1	$V = V_{HIGH}$, $I = 0mA$	$V = 0V$, $I = -25 mA$
B2	$V = 0V$, $I = -25mA$	$V = V_{HIGH}$, $I = 0mA$
J0	$V = -0.9V$, $I = +100mA$	$V = -0.9V$, $I = +100mA$
J1	$V = 0 V$, $I = -100 mA$	$V = V_{HIGH}$, $I = 25 mA$
J2	$V = V_{HIGH}$, $I = 25mA$	$V = 0V$, $I = -100mA$

Notes:

1) Switching time from 50% TTL to 10% or 90% RF Voltage is a function of the PIN diode driver circuit performance as well as the characteristic of the PIN diode itself. An RC (current spiking network) is used on the driver circuit output to provide a large transient current spike to rapidly remove stored charge from the PIN diode. Typical component values are : R = 50 to 220Ω and C = 470 to 1,000 pF.

2) PIN diode minimum reverse DC voltage (V_{HIGH}) is used to maintain high resistance in the OFF PIN diode state and is determined by RF frequency, incident power, duty cycle, characteristic impedance and VSWR as well by the characteristics of the PIN diode. The recommended minimum value of the reverse voltage bias (V_{HIGH}) values are provided in the Minimum Reverse Bias Voltage Table shown below.

Control Truth Table for MSW2T-203X-192

$+V_{cc1} = 5V$ and $+V_{cc2} = 28V$ (unless otherwise noted)

Port J0 – J1	Port J0 – J2	Bias: J1 (Notes: 1 & 2)	Bias: J2 (Notes: 1 & 2)	B1 (Notes: 1 & 2)	B2 (Notes: 1 & 2)	J0 (Notes 1 & 2)
Low Loss	Isolation	$V = 0V$ $I = -100mA$	$V = V_{HIGH}$ $I = 25mA$	$V = V_{HIGH}$ $I = 0mA$	$V = 0V$ $I = -25mA$	$V = -0.9V$ $I = +100mA$
Isolation	Low Loss	$V = V_{HIGH}$ $I = 25mA$	$V = 0V$ $I = -100mA$	$V = 0V$ $I = -25mA$	$V = V_{HIGH}$ $I = 0mA$	$V = -0.9V$ $I = +100mA$

Notes:

1) $28 V \leq V_{HIGH} \leq 125V$

2) PIN diode min reverse DC voltage (V_{HIGH}) to maintain high resistance state in the OFF PIN diode is determined by RF frequency. Incident power, duty cycle, characteristic impedance and VSWR as well as by characteristics of the diode. The recommended min reverse bias voltage (V_{HIGH}) values are provided in the Min Reverse Bias Voltage Table of this data sheet.

MSW2T-203X-192 Minimum Reverse Bias Voltage Table

Part Number	Frequency of Operation (MHz)					
	20 -100	100 - 200	200 - 400	400 – 1,000	1,000 – 4,000	>4,000
MSW2T-2030-192	120V	110V	85V	55V	28V	N/A
MSW2T-2031-192	N/A	N/A	110V	85V	28V	28V
MSW2T-2032-192	N/A	N/A	N/A	85V	55V	28V

Note: N/A denotes an operating frequency outside the normal switch operating frequency range.

MSW2T-203X-192 Absolute Maximum Ratings @ T_A = +25 °C (unless otherwise denoted)

Parameters	Conditions	Absolute Maximum Value
Forward Current – J0, J1 & J2		250mA
Forward Current @ B1 or B2		150 mA
Reverse Voltage – J0, J1, J2, B1 B2		125V
Forward Diode Voltage	I _F =250mA	1.2V
Operating Temperature		-55 °C to +125°C
Storage Temperature		-65 °C to +150 °C
Junction Temperature		+175 °C
Assembly Temperature	T = 10 seconds	+260 °C
CW Incident Power Handling – J0, J1, J2 (note 1)	Source & Load VSWR = 1.5 : 1 (Cold Switching) T _{CASE} = 85°C	50 dBm
Peak Incident Power Handling J0, J1, J2 (Note 1)	Source & Load VSWR = 1.5 : 1 T _{CASE} = 85°C, cold switching, pulse width = 10 uS and duty cycle = 1%	57 dBm
Total Dissipated RF & DC Power (Cold Switching) See Notes below: 1 & 2	T _{CASE} = 85°C, cold switching	8 W

Notes:

- 1) Backside RF, DC and Thermal Ground area of device must be completely solder attached to RF circuit board vias for proper electrical and thermal circuit grounding.

MSW2T-2030-192 Small Signal Parametric Performance:

MSW2T-2030-192 Insertion Loss vs. Frequency

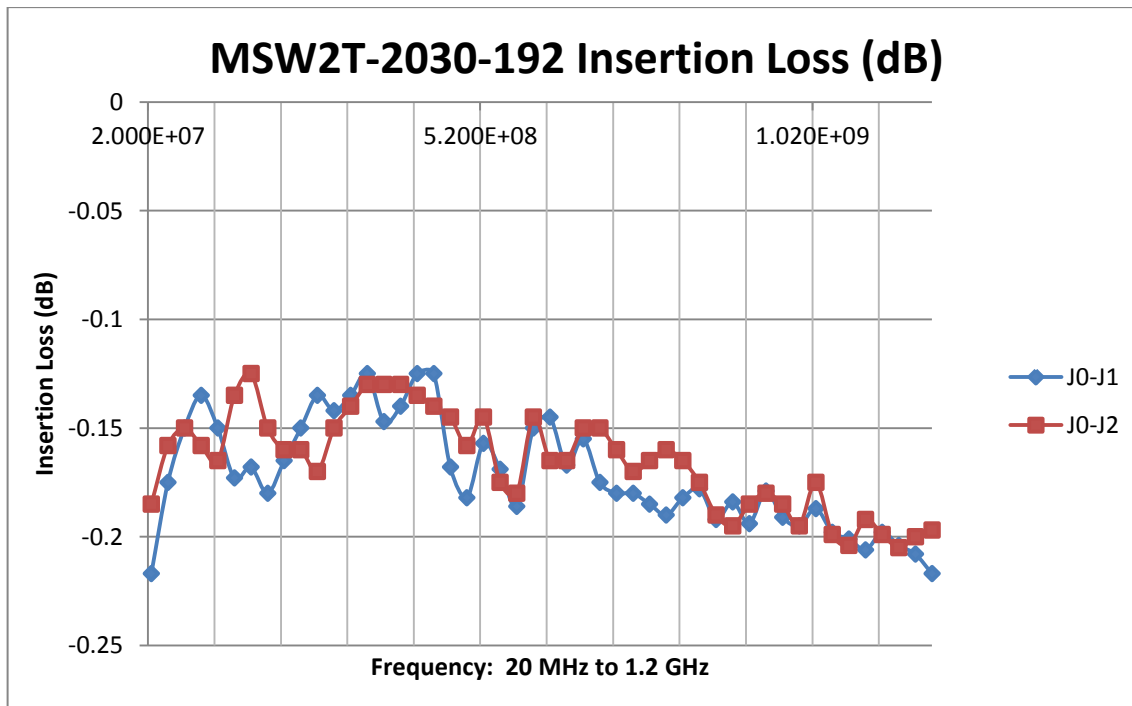

MSW2T-2030-192 Return Loss vs. Frequency

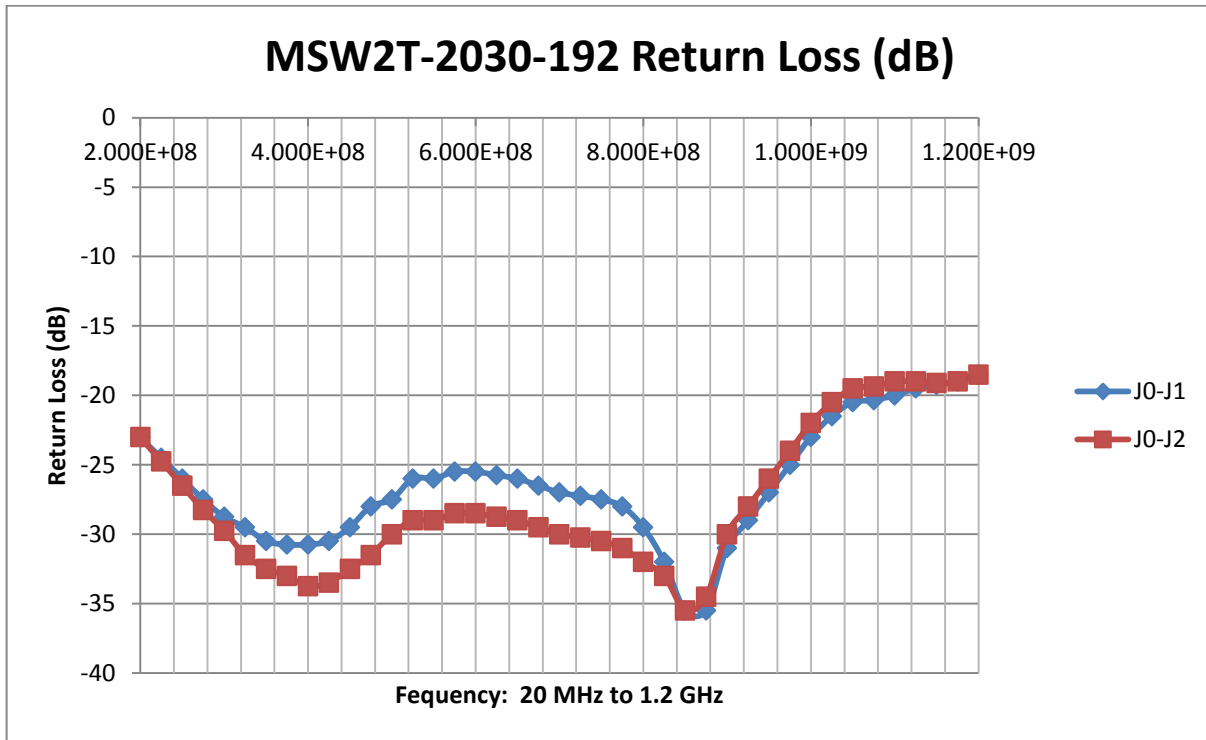

MSW2T-2030-192 Isolation vs. Frequency

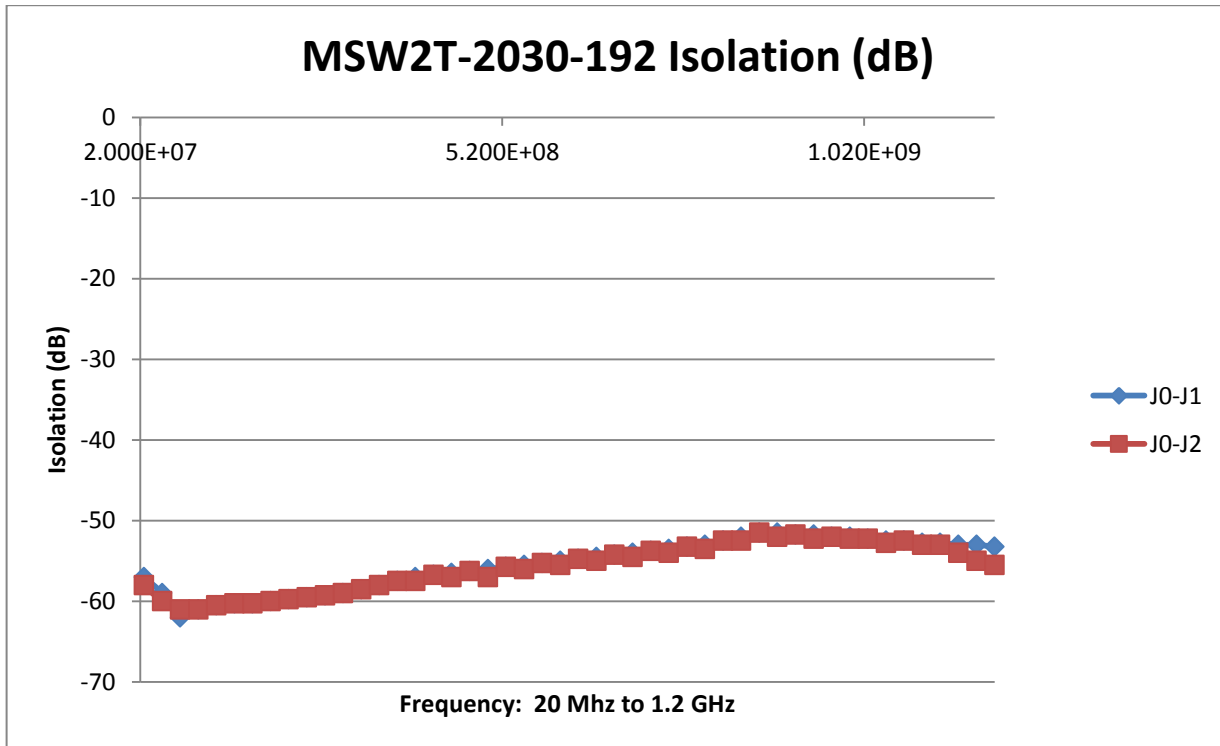

MSW2T-2031-192 Small Signal Parametric Performance:

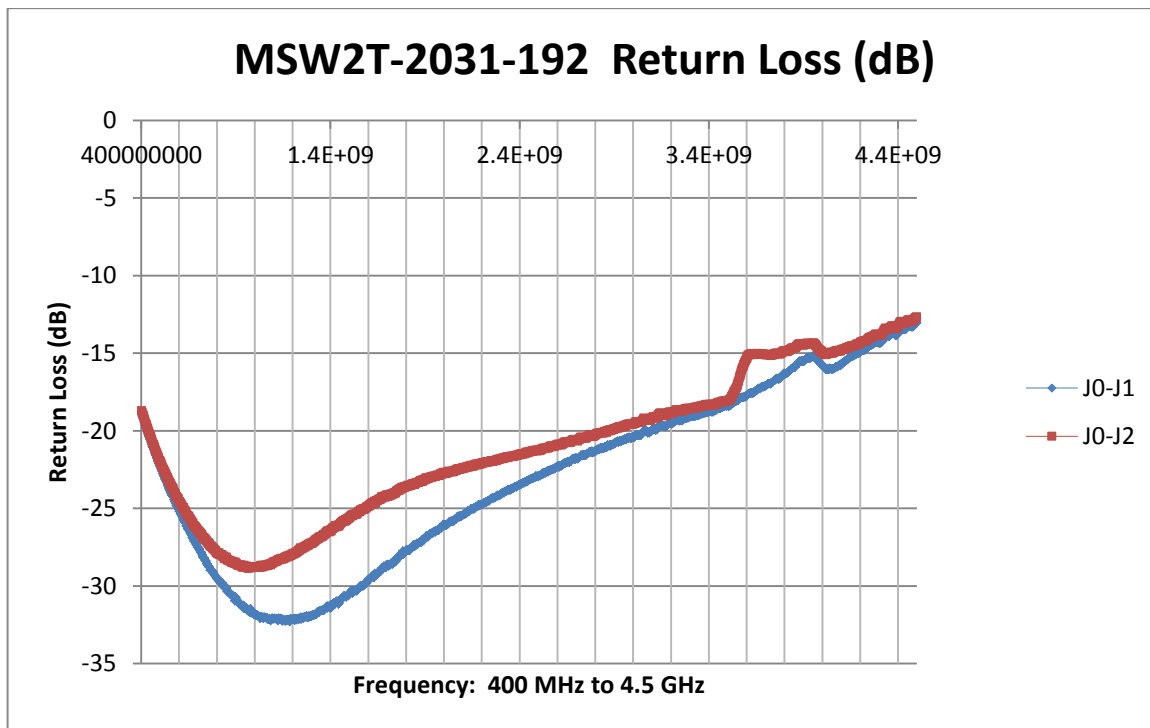
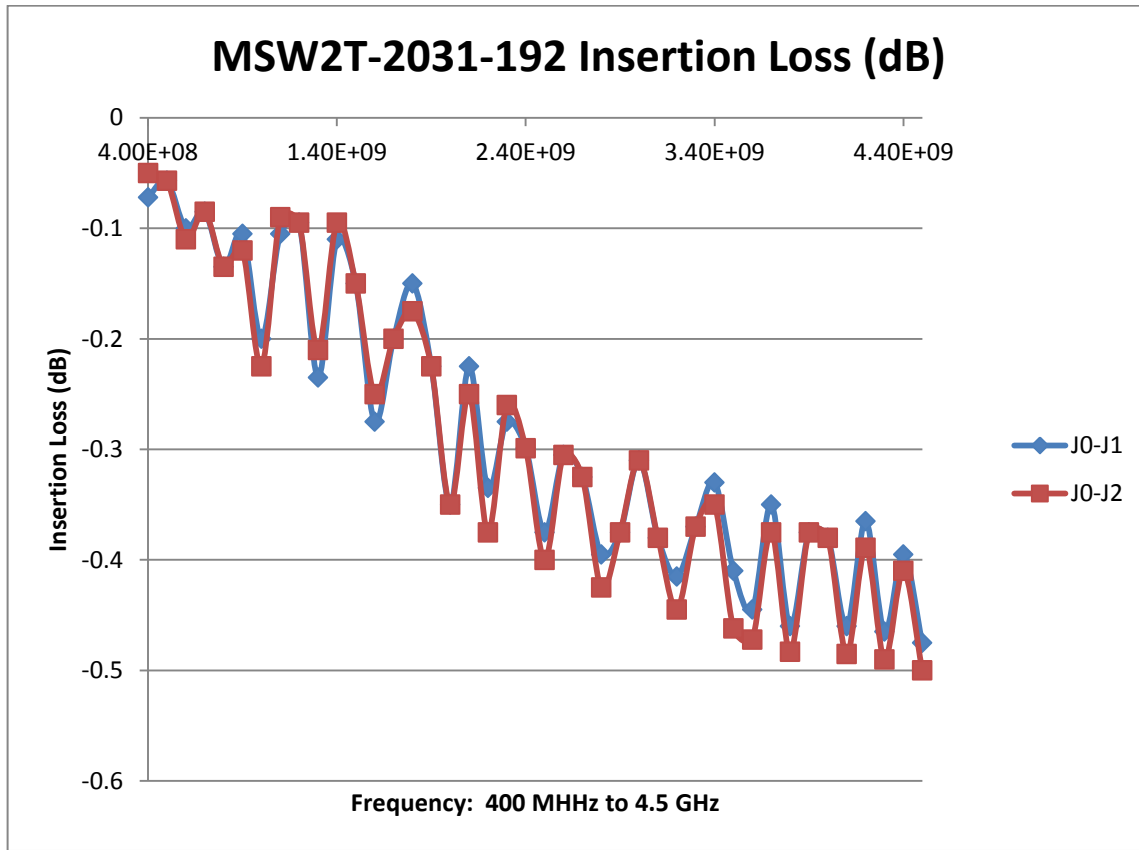

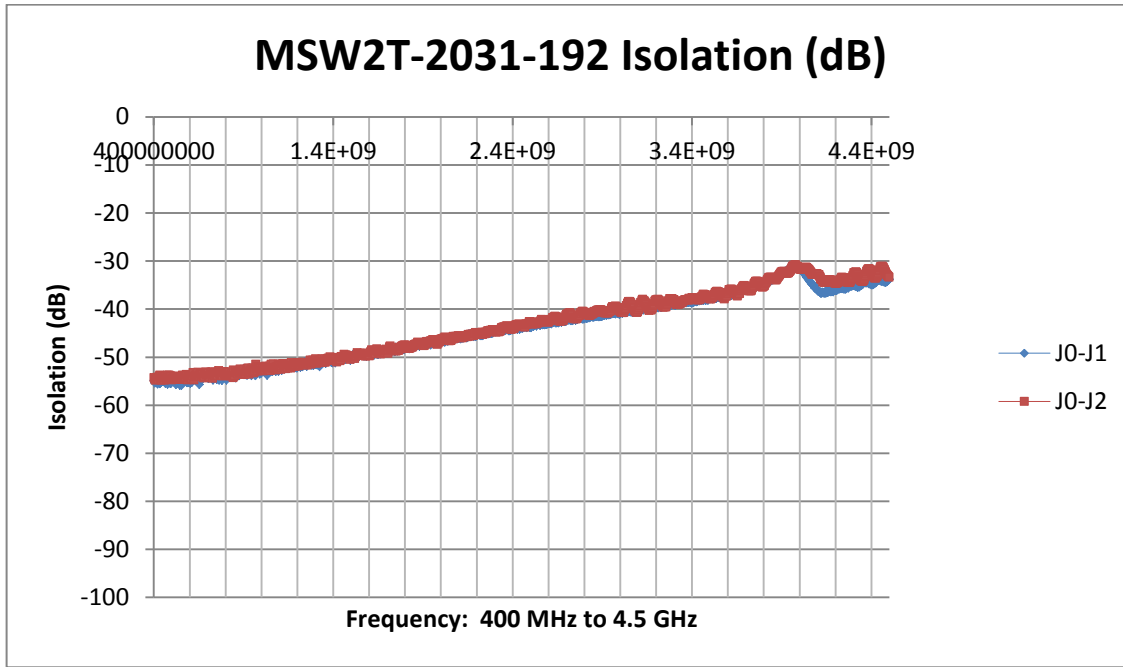

MSW2T-2032-192 Small Signal Parametric Performance:

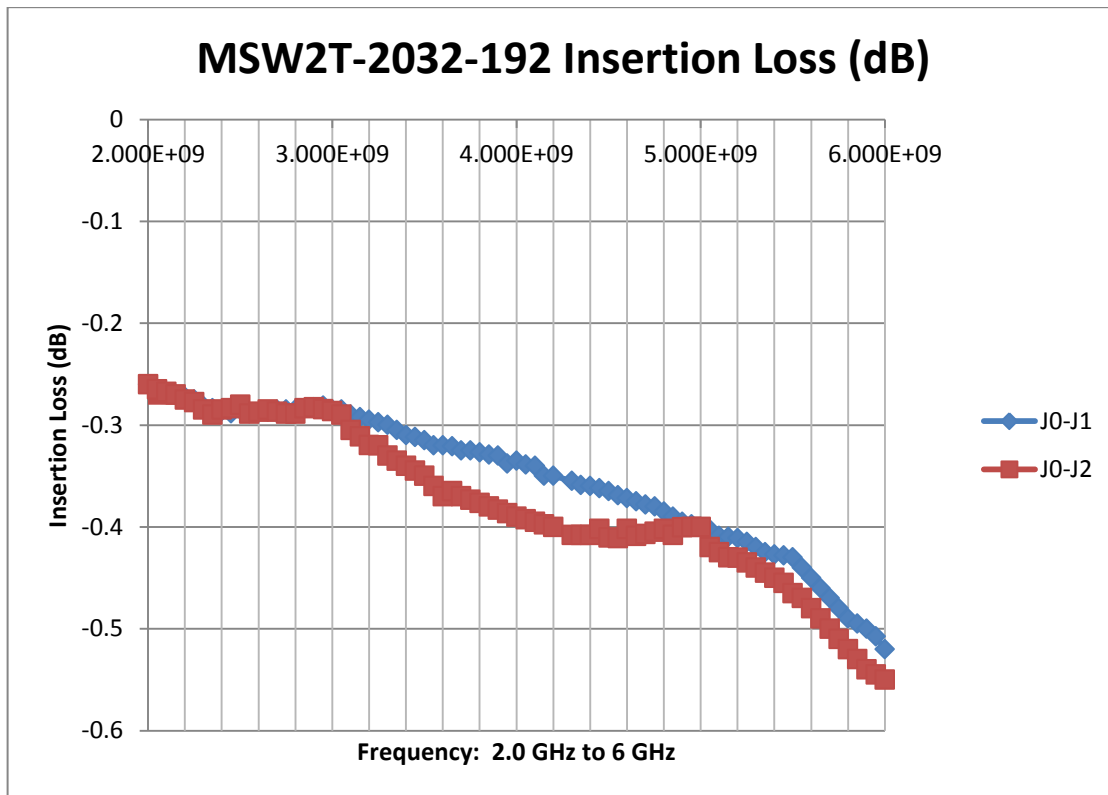

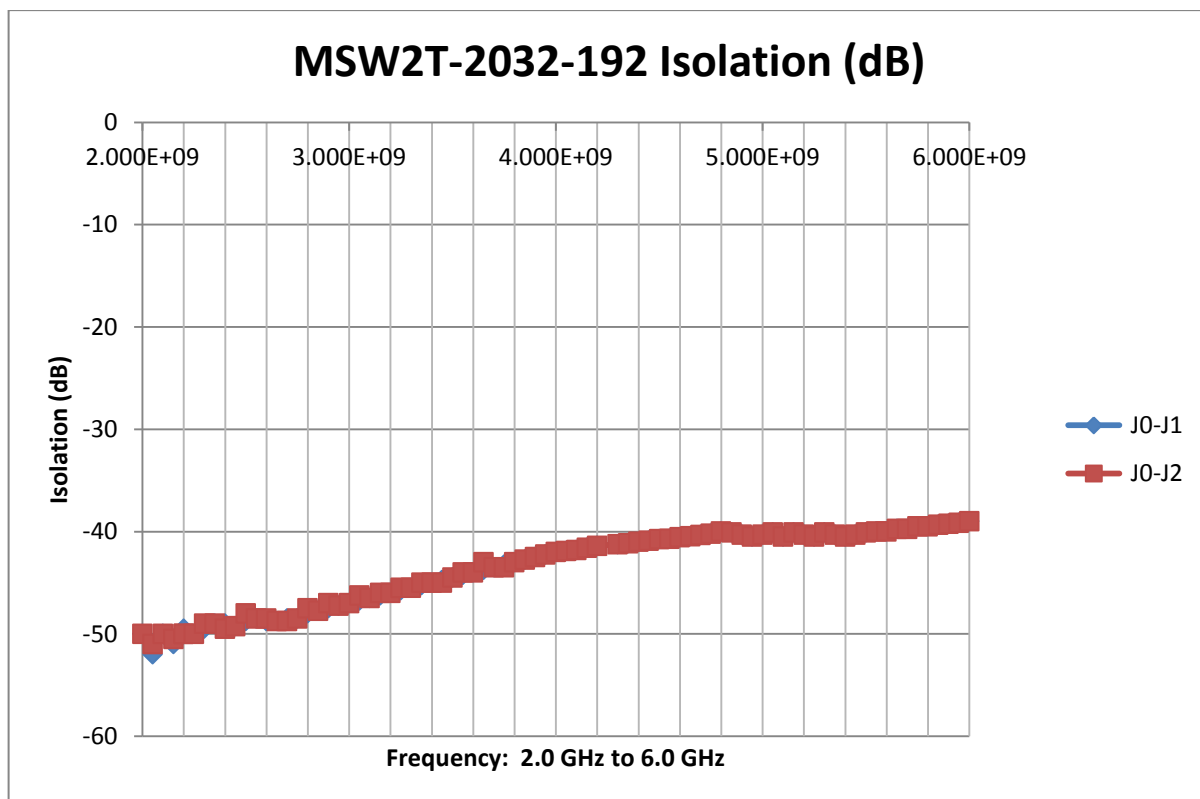
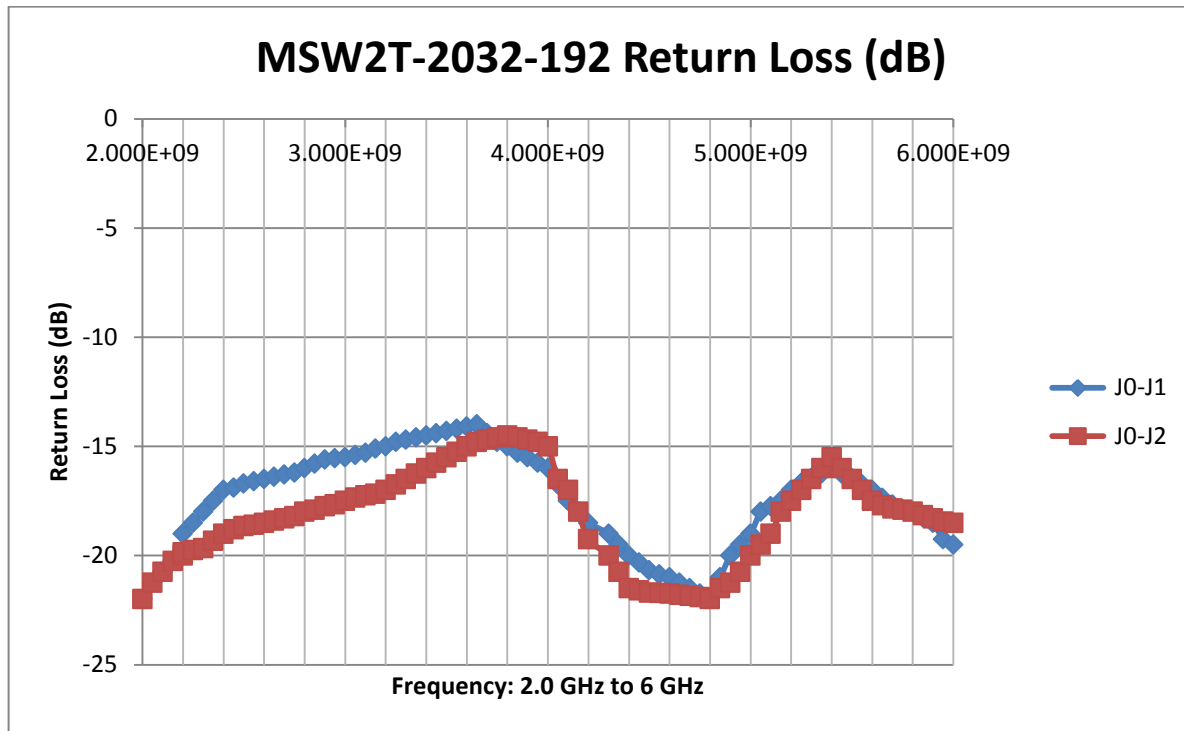

Assembly Instructions

The MSW2T-203X-192 family of High Power Switches are available in either tube or Tape & Reel format. The MSW2T-203X-192 may be attached to the printed circuit card using solder reflow procedures using either RoHS or Sn63/ Pb37 type solders per the Table and Temperature Profile Graph shown below:

Profile Parameter	Sn-Pb Assembly Technique	RoHS Assembly Technique
Average ramp-up rate (T_L to T_P)	3°C/sec (max)	3°C/sec (max)
Preheat		
Temp Min (T_{smin})	100°C	100°C
Temp Max (T_{smax})	150°C	150°C
Time (min to max) (t_s)	60 – 120 sec	60 – 180 sec
T_{smax} to T_L		
Ramp up Rate		3°C/sec (max)
Peak Temp (T_P)	225°C +0°C / -5°C	260°C +0°C / -5°C
Time within 5°C of Actual Peak Temp (T_P)	10 to 30 sec	20 to 40 sec
Time Maintained Above:		
Temp (T_L)	183°C	217°C
Time (t_L)	60 to 150 sec	60 to 150 sec
Ramp Down Rate	6°C/sec (max)	6°C/sec (max)
Time 25°C to T_P	6 minutes (max)	8 minutes (max)

Solder Re-Flow Time-Temperature Profile

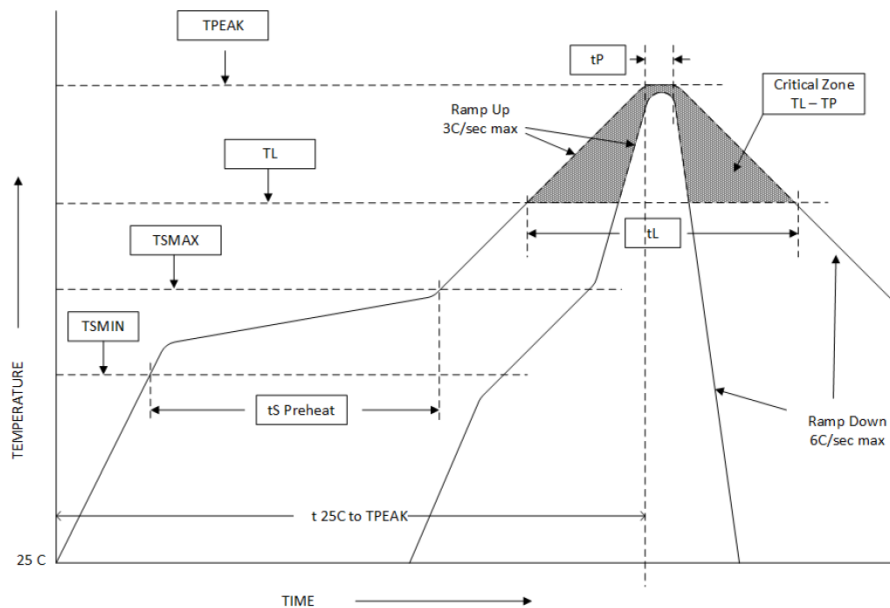

MSW2T-203X-192 SP2T Package Outline Drawing

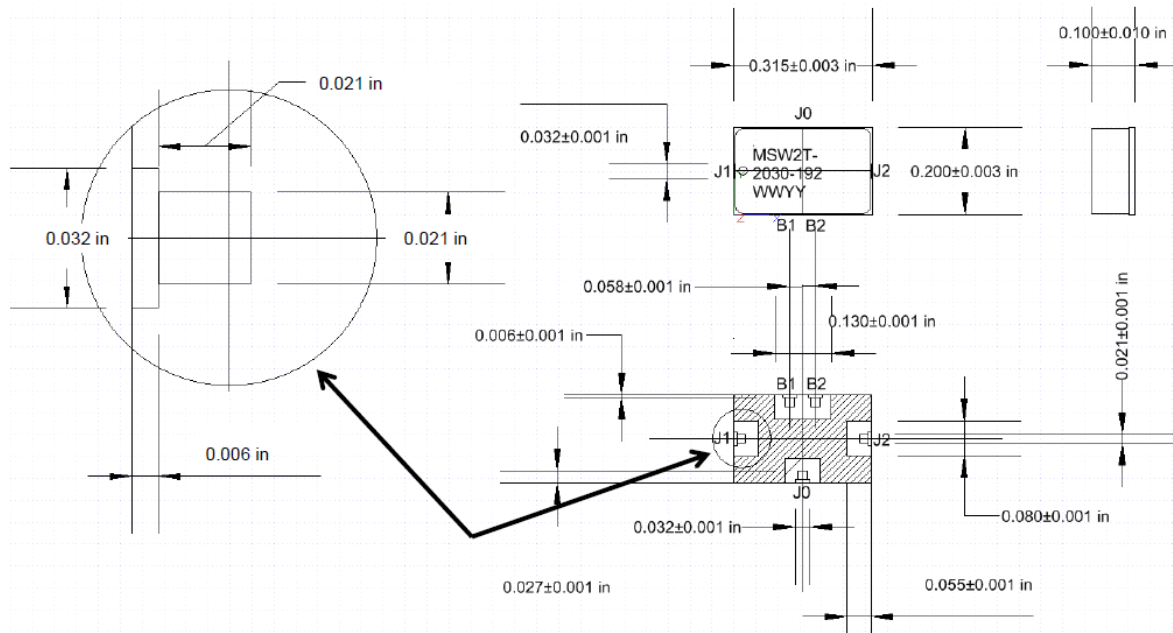

Note: Metalized area on backside is the RF, DC and Thermal ground. In user's end application this surface temperature must be managed to meet the power handling requirements.

Thermal Design Considerations:

The design of the MWT-203X-192 family of High Power Switches permits the maximum efficiency in thermal management of the PIN Diodes while maintaining extremely high reliability. Optimum switch performance and reliability of the switch can be achieved by the maintaining the base ground surface temperature of less than 85°C.

Recommended RF Circuit Solder Footprint for the MSW2T-203X-192

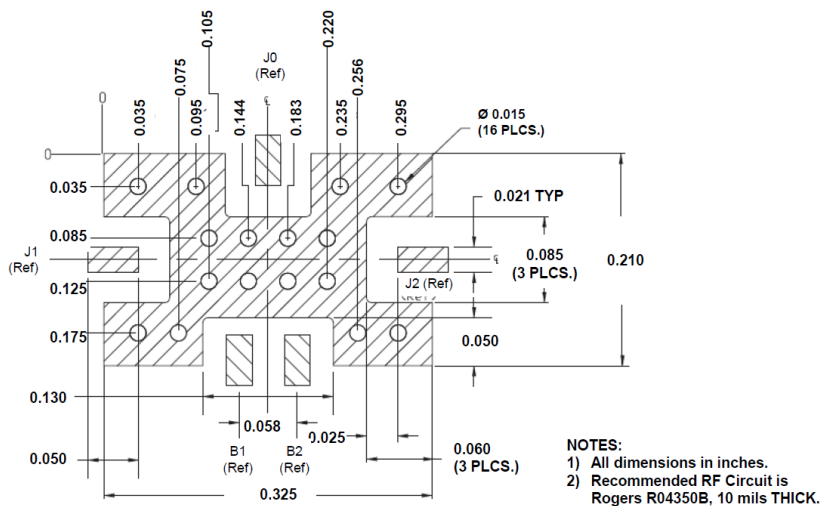

MSW2T-2031-192 Evaluation Board Schematic & Bill-of-Materials

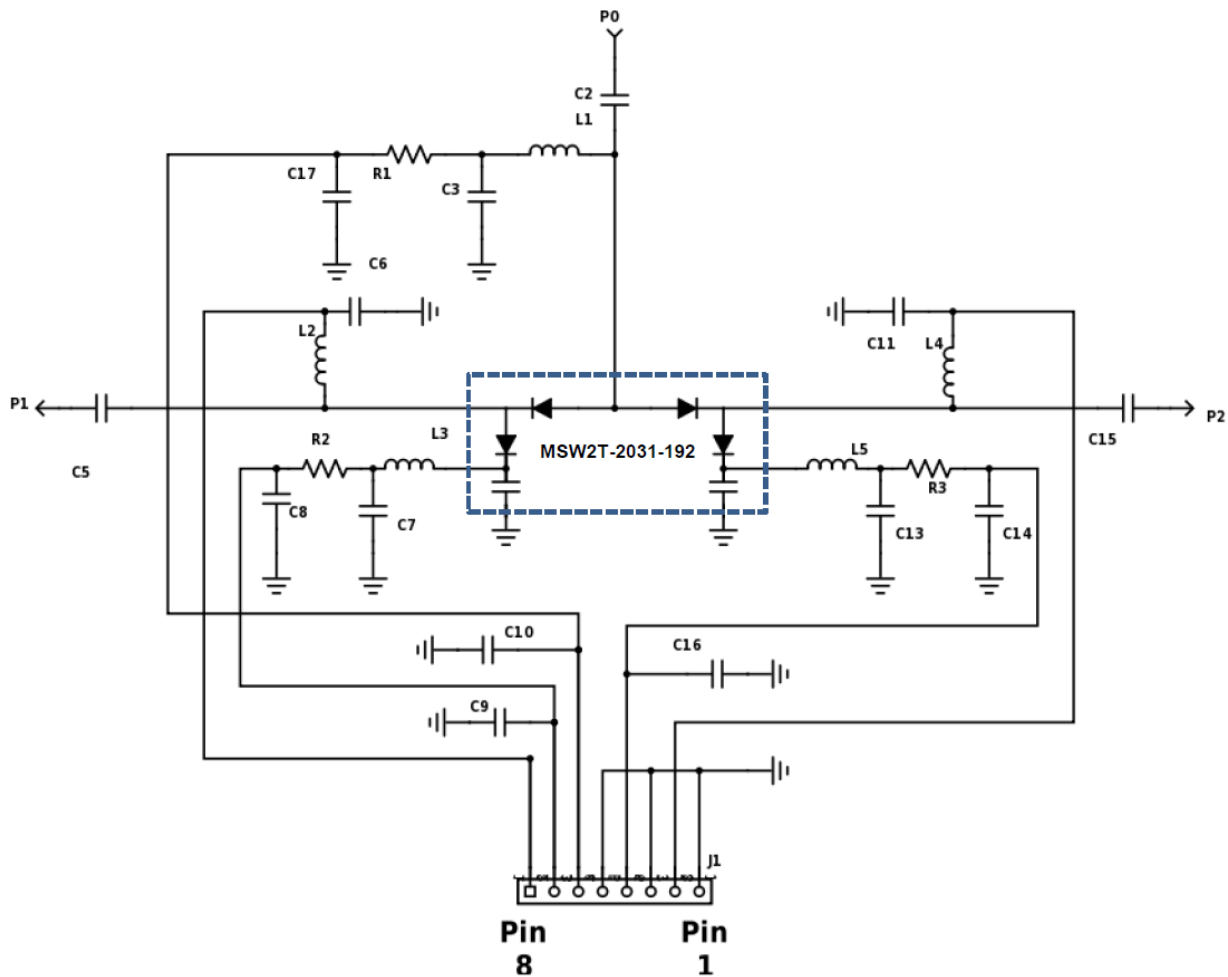

Small Signal Bias Components

Component	Nominal Value	Manufacturer	Part Number	Description
C2, C5, C15	27 pF	Johanson Technology	251R14S270JV4T	27 pF ±5%, 250V, Ceramic Cap COG NP0 0603 (IN)
L1, L2, L3, L4, L5	47 nH	Murata	LQW2BAS47NJ00L	47 nH, 500mA, 0805 (IN)
R1	33Ω	Panasonic	ERJ-1TYJ330U	RES SMD 33Ω ±5%, 1W, 2512 (IN)
R2, R3	560Ω	Panasonic	ERJ-1TYJ561U	RES SMD 560Ω ±5%, 1W, 2512 (IN)
C3, C6, C7, C8, C9, C10, C11, C13, C14, C16, C17	270 pF	TDK	C1608C0G2E271J080AA	CAP CER 270pF, 250V COG 0603 (IN)

MSW2T-2031-192 Evaluation Board

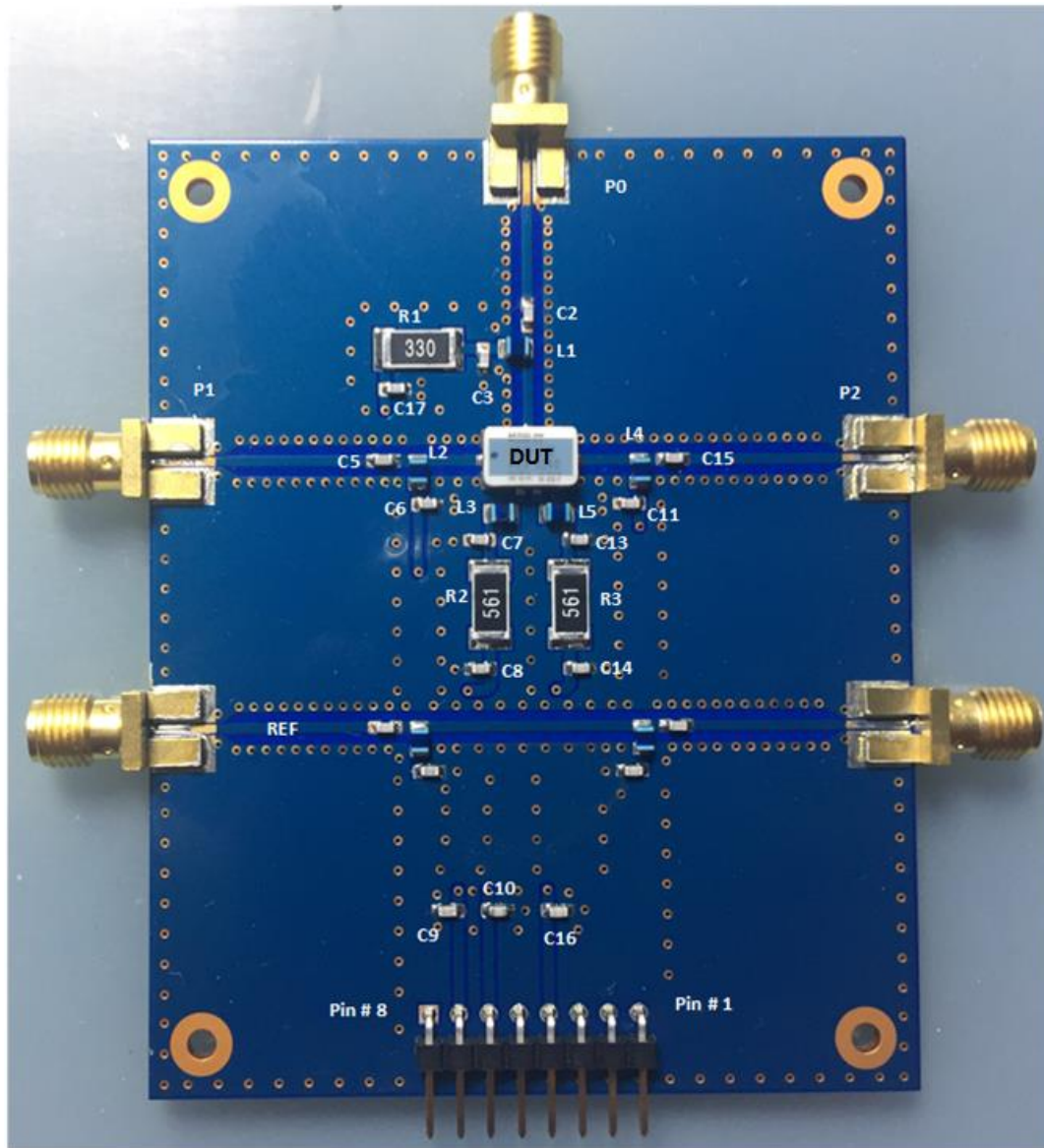

Test Condition 1: P0-P1 Low Loss & P0-P2 ISOLATION

Header J1							
Pin #8	Pin #7	Pin #6	Pin #5	Pin #4	Pin #3	Pin #2	Pin #1
0V/GND -100mA	+20V 0mA	+5V ~100mA	GND	0V/GND -35mA	GND	+20V ~35mA	GND

Test Condition 2: P0-P1 ISOLATION & P0-P2 LOW LOSS

Header J1							
Pin #8	Pin #7	Pin #6	Pin #5	Pin #4	Pin #3	Pin #2	Pin #1
+20V ~35mA	0V/GND -35mA	+5V ~100mA	GND	+20V 0mA	GND	0V/GND -100mA	GND

Part Number Ordering Details:

Part Number	Packaging
MSW2T-2030-192	Tube
MSW2T-2030-192TR	Tape & Reel (250 pcs)
MSW2T-2031-192	Tube
MSW2T-2031-192TR	Tape & Reel (250 pcs)
MSW2T-2032-192	Tube
MSW2T-2032-192TR	Tape & Reel (250 pcs)